

Movements in new dimensions

Industrial gearboxes – comprehensive modular system

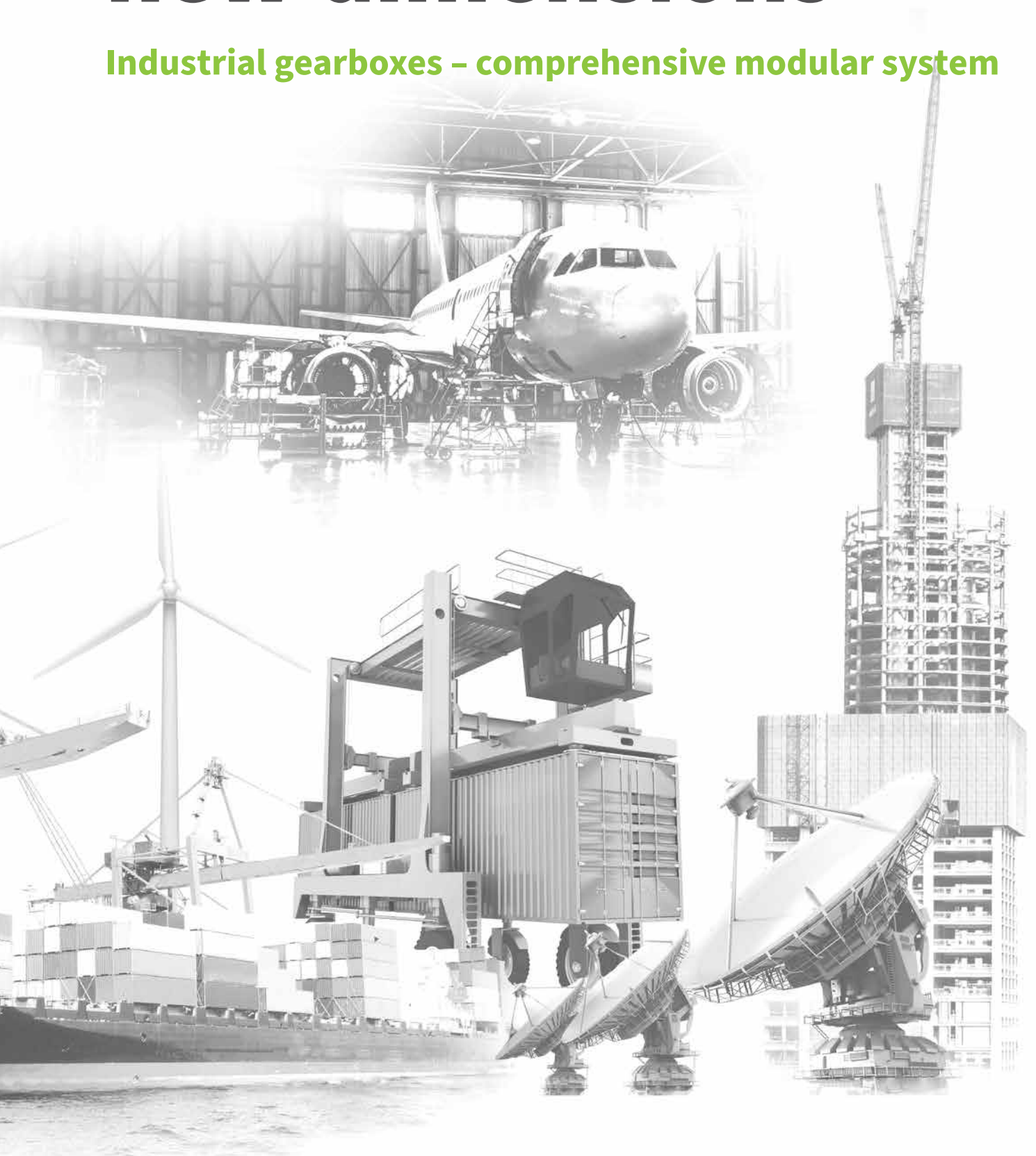



Uplifting precise

„It is our aim at ZIMM to consistently improve our performance and raise the quality of our industrial gearboxes to a new level. In the following pages, discover how we have managed to do so while always maintaining a high level of precision. Alternatively, you are always welcome to experience a guided factory tour.“

Gunther Zimmermann
CEO

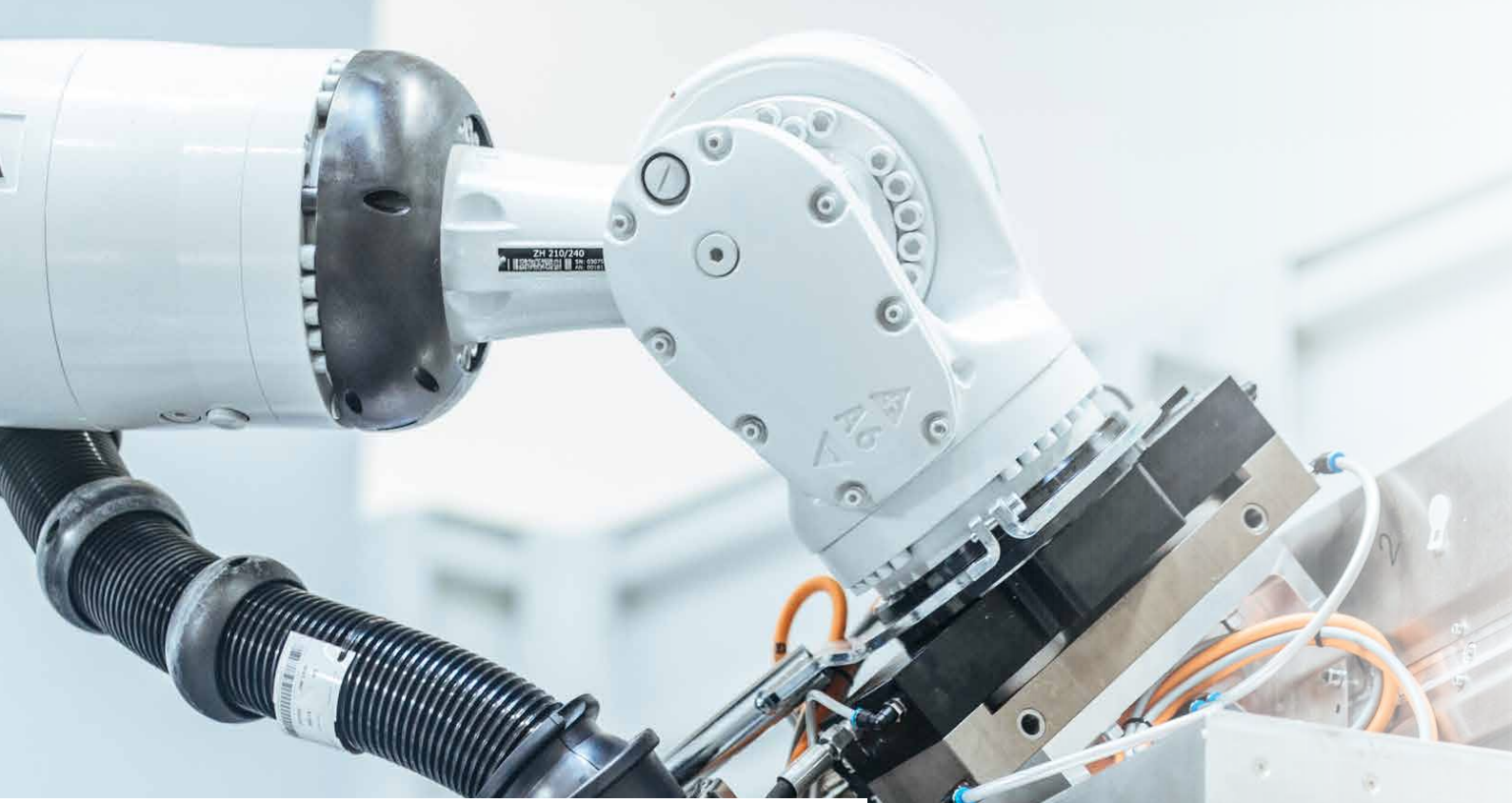

Movement with precision

ZIMM company

As the European market leader, we offer you a unique range of screw jack systems and, as of 2023, also electromechanical actuators.

There are five decades of experience within each ZIMM screw jack. Since 1991, we have been systematically improving our know-how regarding our ZIMM modular system to meet your requirements as a customer faster, more precisely, and more reliably than one may at first expect. ZIMM is delighted to improve our gearboxes and thankful to continue our success constantly. At ZIMM, you receive solutions that have been proven repeatedly and have therefore convinced well-known machine builders and industrial companies in countless industries to rely on ZIMM. Our robust integrated systems, based on the ZIMM modular system combined with customer-specific designs, are used anywhere loads must be controlled and positioned precisely – whether the load is just a few kilograms or hundreds of tonnes per gearbox. As an owner-managed family company, it is our concern to supply you with the best tools in the industry and outstanding delivery reliability.

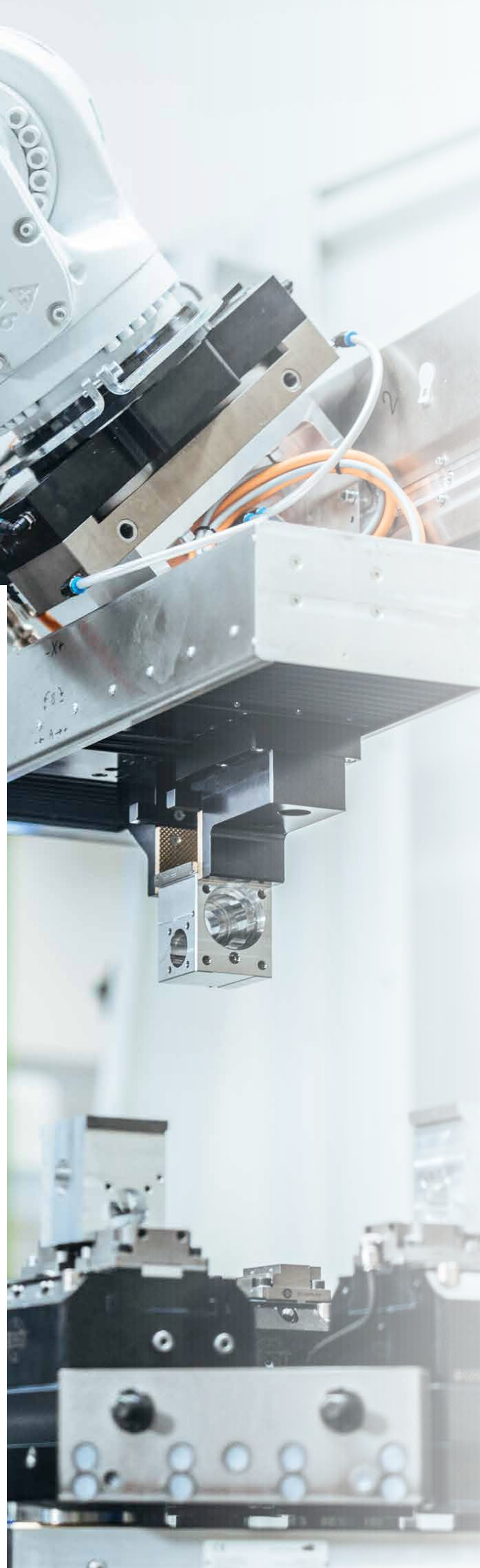

The top 5 arguments for ZIMM

1

Flawless design in half the time

- Massive time saving in design
- Complete systems with all drives and connections
- Software prevents design errors
- Generate and download CAD in real time

2

Most extensive modular system

- Proven standard customised components
- More than 7,000 useful combination options
- Engineering service for special requirements

3

Pioneering product design

- Continuous improvement and further development
- Harmonious design also for a visible installation
- Well thought-out details and product advantages
- Standardised interfaces and installation sizes

4

Proven and tested quality

- Standard anti-corrosion protection
- Comprehensive test, measurement and inspection systems
- ISO 9001: 2015 certified

5

Reliable and fast delivery

- Order processing via website possible
- Flexibility and capacity for large quantities
- High delivery reliability

Key benefits for every use

Electromechanical actuators and screw jacks are the latest technology for the precise lifting and positioning of components or loads.

- 1 Spindle with trapezoidal or ball thread**
Depending on the requirements for economy, accuracy and speed
- 2 High performance gearing**
Hardened and ground for outstanding durability and energy efficiency
- 3 Standardised flanges and attachments**
In stock for commercially available engines
- 4 Corrosion protection ex works**
Consistent basic protection as standard; further protection levels and desired colours possible

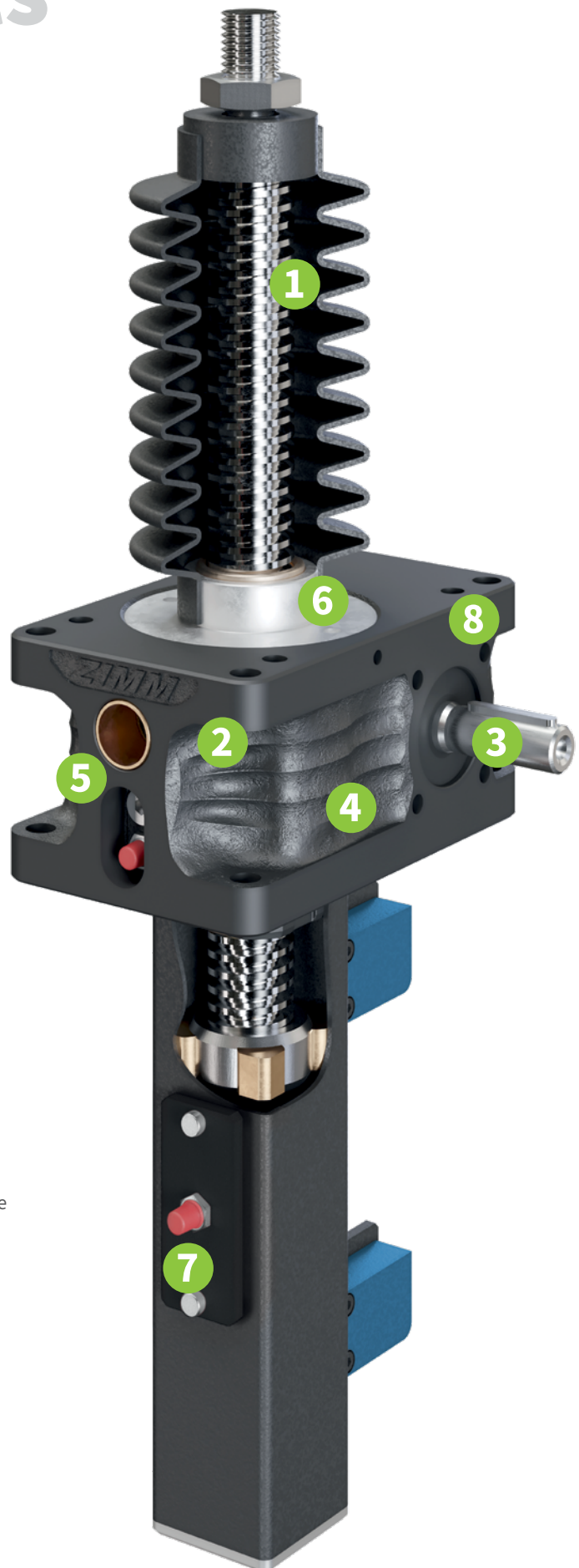

With their performance, accuracy and cost-effectiveness, screw jacks and actuators are replacing hydraulic applications in more and more areas of use. Next, you can see the most important advantages.



5 Integrated sliding swivel bearings
Matching bearing blocks, as standard

6 Sealed gear
Lubricated-for-life for high speeds and operating times

7 Lubrication without downtimes*
Lubrication possible also during operation
**Must put actuator into respective lubrication position first.*

8 Ready for all installation positions
With prepared holes for all types of installation; Installation upside down with nominal load



**Wherever
there's
ZIMM, there's
movement**



Areas of application



Steel industry, rolling mills



Paper and plastics industry



Antenna systems



Cranes



Timber industry



Cleanrooms



Food industry

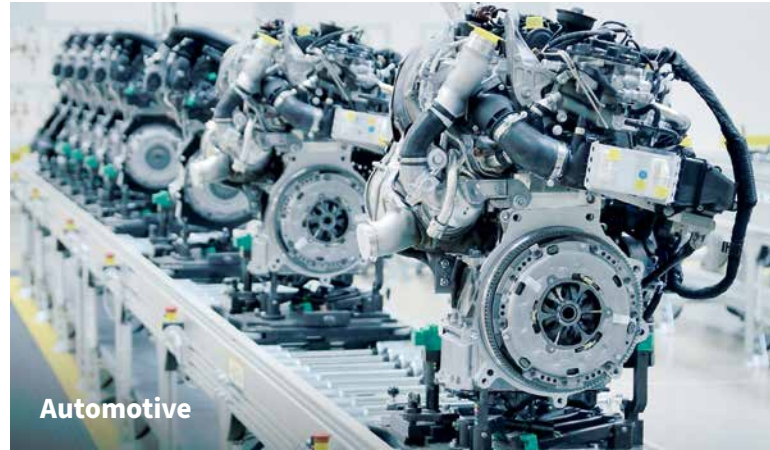

Automotive



Straightening and profiling



Aerospace



Stage technology



Construction industry

Faster and easier to the complete lifting system

ZIMM modular system

At ZIMM, speed, know-how and customer friendliness have a system. The ZIMM modular system sets a standard with its scope, versatility and possible combinations. And above all, it offers you the possibility of putting together really complete lifting systems with attachments, connecting shafts, safety features and other.

Basis element gearbox

ZIMM screw jack in 14 sizes
with a lifting force of 2 kN to 1,000 kN;
more than 1,000 system components ex stock,
more than 7,000 combinations possible

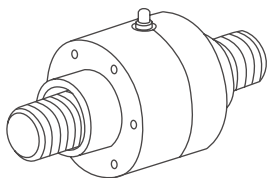

- + Spindles and nuts**
Versatile range from
16 to 160 mm in diameter
for trapezoidal and ball screws

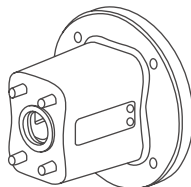

- + Flanges, motors
and attachments**
Common flanges, motors
and guards

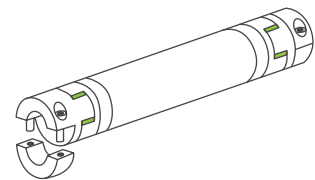

- + Connection shafts**
Large selection of connection
shafts and couplings

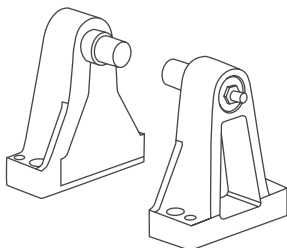

- + Accessories for
swivelling**
Suitable for all gear sizes

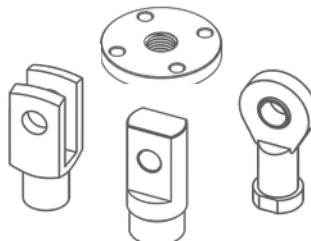

- + Connections
and fastenings**
The most common heads and mounting
flanges in the standard range

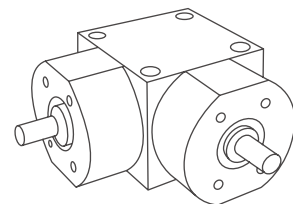

- + Bevel gear units**
42 different high-performance
bevel gear units



Z-350



ZIMM configurator

with tangible benefits

ZIMM supports you with sophisticated digital tools during selection, construction and ordering.

The ZIMM product configurator accompanies you to your screw jack or lifting system easily, quickly and intuitively. Sophisticated plausibility checks in the background prevent planning errors. Just give it a try.

5 steps to a perfectly designed lifting system

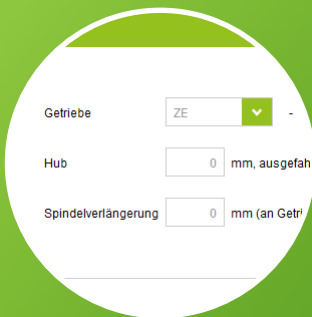

1



2



3



4



5

1. Enter parameter
2. Select components
3. Configure
4. Check system preview
5. Download 3D data



Reach new levels in all areas

with lifting forces from 2 kN to 1,000 kN



Worldwide in use

Global service
in 37 countries

ZIMM GmbH **Lustenau, Austria**

Corporate headquarters of the ZIMM Group.
Development, production and sales of
industrial gearboxes and matching parts.

ZIMM USA Inc. **Bloomington/Chicago**

Sales and
service office.

ZIMM Turkey **Ankara, Turkey**

Casting, series production
and mechanical processing.





Your enquiry is our drive



ZIMM GmbH

Millennium Park 3, A-6890 Lustenau

T +43 5577 806-0, E info@zimm.com